

**Working Height Tolerance (in the direction of pin stroke)**

The recommended working height, into which the pin is compressed, is as follows.

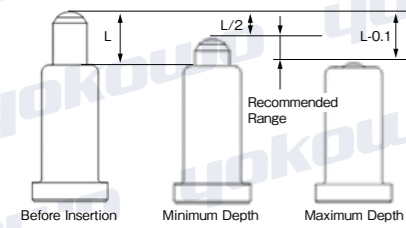

**Minimum Depth**

Be sure to insert more than half of the projecting portion (L mm). If it is not inserted deeply enough, the contact resistance may be unstable.

**Maximum Depth**

Be careful not to over insert the pin. The shoulder portion of the tube may become damaged, and cause the pin to not decompress.

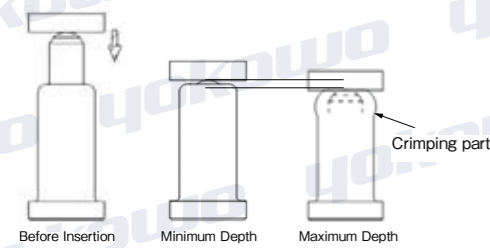

**Recommended Land Pattern**

The specifications of the recommended land pattern are as follows.

**Recommended Land Pattern**

Leave sufficient space to permit solder fillet formation, so soldering strength will be secured.

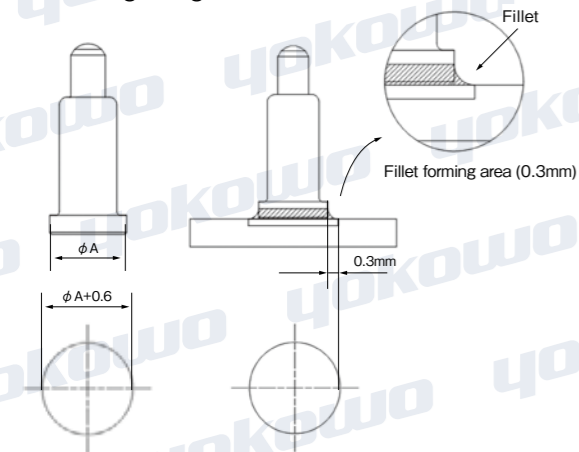

**Solder Paste Thickness**

The co-planarity of the product is max. 0.1. Make sure that the solder paste thickness is at least 0.1mm.

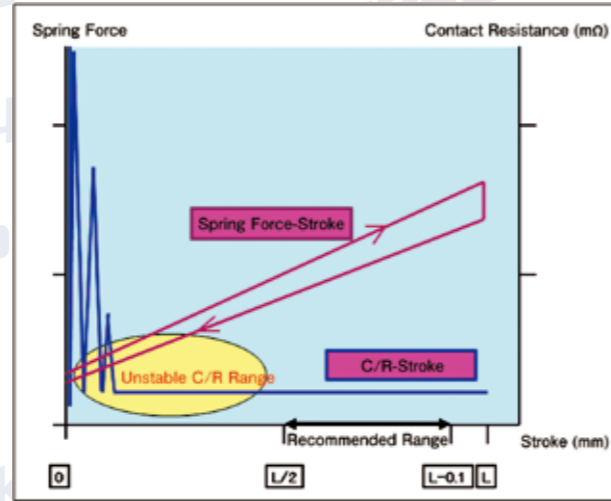
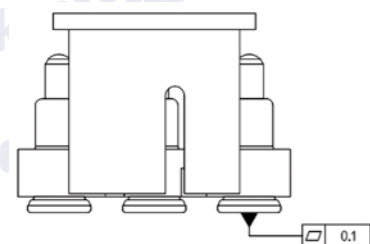

**Mounting Area**

The product comes with pick and place caps. Therefore, be sure to spare a mounting area that is wide enough to fit the outlines of the caps, to permit tasks for eliminating the caps, and to prevent interference between parts that are next to each other.

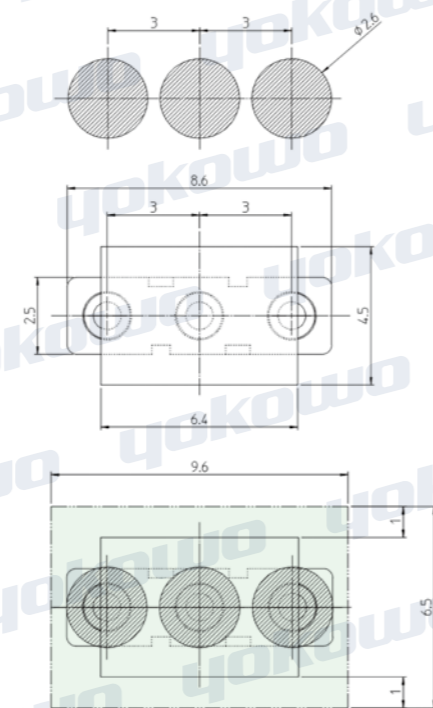

**Counterpart Terminal (Female Side Connector)**

The recommended counterpart terminal is as described below.

**Outline of Counterpart Terminal**

Be sure to use a counterpart terminal that is  $\phi 2\text{mm}$  or larger, by considering the misalignment of contacts, mounting misalignment, and misalignment after mating.

- Misalignment of Contacts = Product's Pitch Tolerance (0.1mm) + Pin Deflection (0.2mm) + Part's Tolerance (0.05mm)
- Mounting Misalignment = 0.3mm
- Misalignment after Mating = 0.3mm

**Materials, Roughness, and Hardness of the Counterpart Terminal**

The recommended material of the counterpart terminal is brass plate, copper alloy plate, or substrate. The contact surface must be flat, smooth, and gold-plated.

**Plating for the Counterpart Terminal**

The recommended plating for the counterpart terminal is "Gold plating of at least  $1\mu\text{m}$  over Nickel underplate," which is equivalent to the plating applied for pins of SPC products.

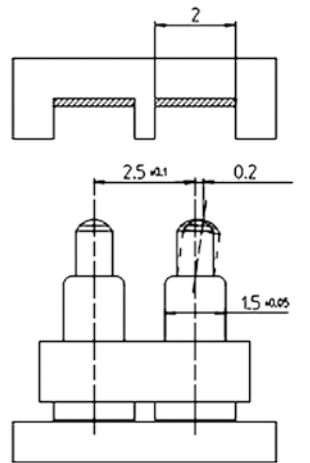

**How to Mate the Pin with the Counterpart Terminal**

Note the following when mating the SPC with the counterpart terminal.

**Method of Fitting**

Be sure to fit the pin into the counterpart terminal vertically.

If fitting from the lateral side of the SPC, the SPC may become deformed and cause poor contact resistance.

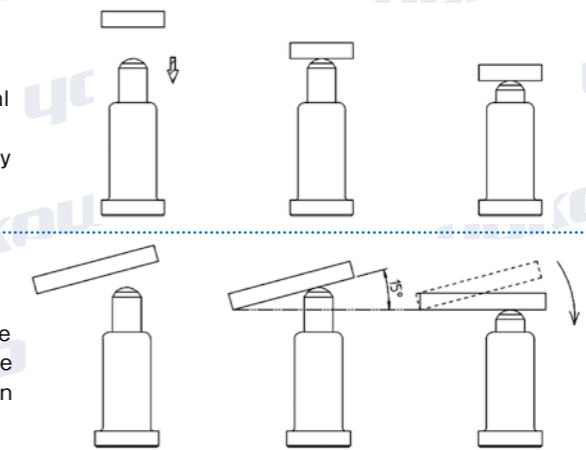

When fitting from an oblique angle, make sure that the angle between the two is smaller than 15 degrees at the time of contact. Be sure not to repeat mating more than 2,000 times in this way.

Do not slide the counterpart terminal on the pin. The plating on the top end of the pin may scratch off, and this will lead to poor contact resistance.

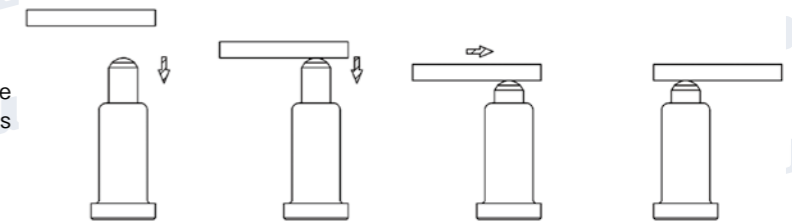

**Allowable Angle with the Counterpart Terminal**

Be sure to keep the angle between the counterpart terminal and SPC from 85 degrees to 95 degrees (within the range of  $\pm 5$  degrees from the verticality).

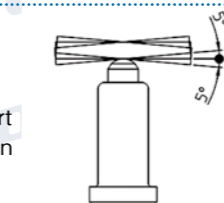

# Pressure – Stroke Curve Graph

# Pressure – Stroke Curve Graph

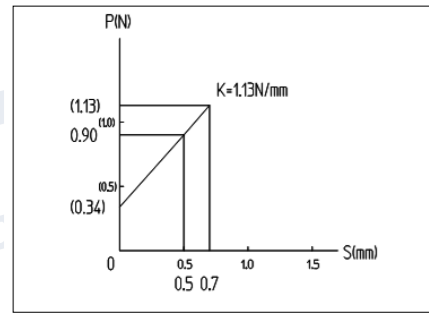

**J-2307P-1-00-0000**

0.5mm (recommended compressed stroke) : 0.90N±0.2N  
Full stroke : 0.7mm

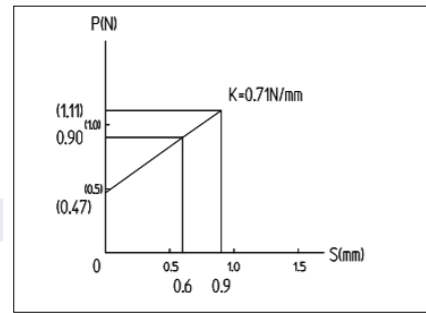

**J-2509P-1-00-0000**

0.6mm (recommended compressed stroke) : 0.90N±0.20N  
Full stroke : 0.9mm

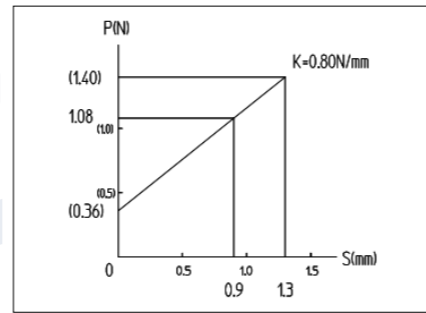

**J-3413P-1-00-0000**

0.9mm (recommended compressed stroke) : 1.08N±0.25N  
Full stroke : 1.3mm

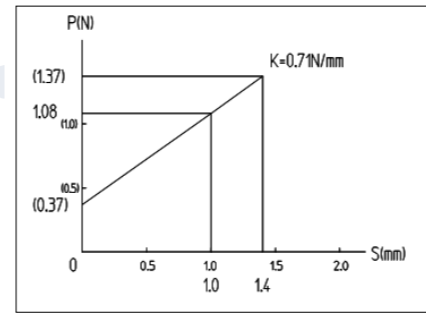

**J-3614P-1-00-0000**

1.0mm (recommended compressed stroke) : 1.08N±0.25N  
Full stroke : 1.4mm

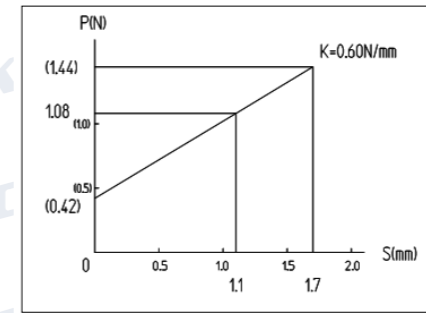

**J-5517P-1-00-0000**

1.1mm (recommended compressed stroke) : 1.08N±0.25N  
Full stroke : 1.7mm

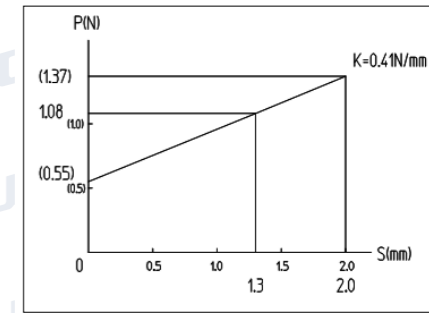

**J-6520P-1-00-0000**

1.3mm (recommended compressed stroke) : 1.08N±0.25N  
Full stroke : 2.0mm

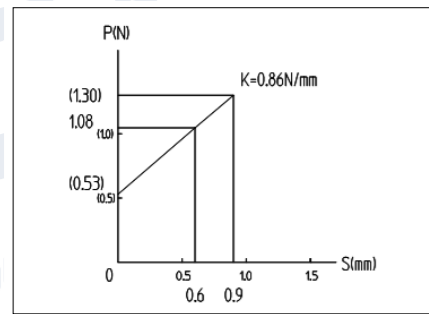

**J-2809P-1-00-0000**

0.6mm (recommended compressed stroke) : 1.08N±0.25N  
Full stroke : 0.9mm

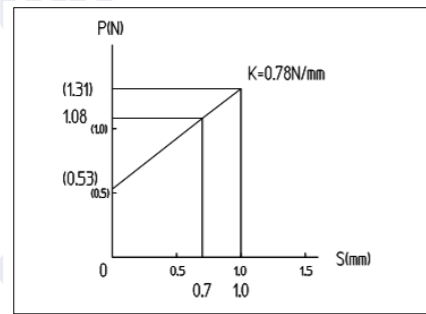

**J-2910P-1-00-0000**

0.7mm (recommended compressed stroke) : 1.08N±0.25N  
Full stroke : 1.0mm

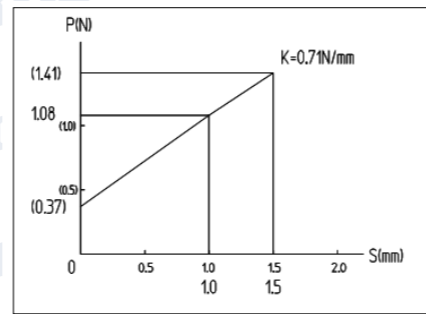

**J-3915P-1-00-0000**

1.0mm (recommended compressed stroke) : 1.08N±0.25N  
Full stroke : 1.5mm

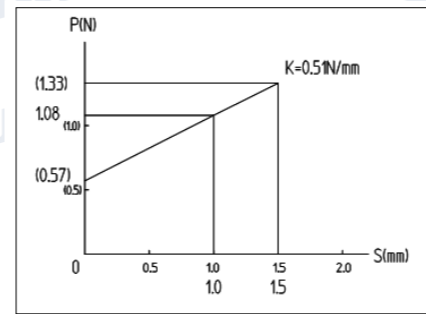

**J-4215P-1-00-0000**

1.0mm (recommended compressed stroke) : 1.08N±0.25N  
Full stroke : 1.5mm

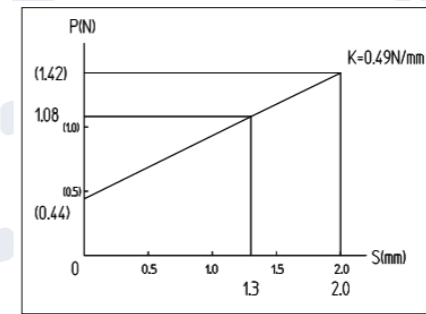

**J-6220P-1-00-0000**

1.3mm (recommended compressed stroke) : 1.08N±0.25N  
Full stroke : 2.0mm

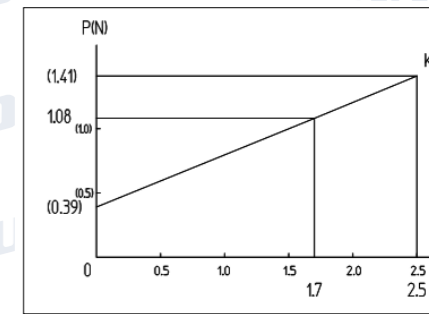

**J-7025P-1-00-0000**

1.7mm (recommended compressed stroke) : 1.08N±0.25N  
Full stroke : 2.5mm

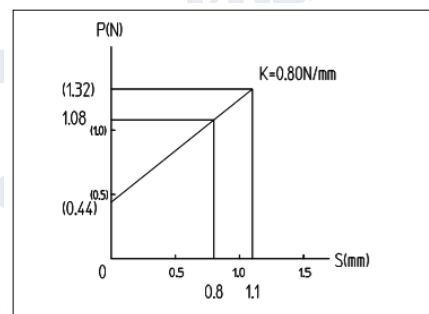

**J-3111P-1-00-0000**

0.8mm (recommended compressed stroke) : 1.08N±0.25N  
Full stroke : 1.1mm

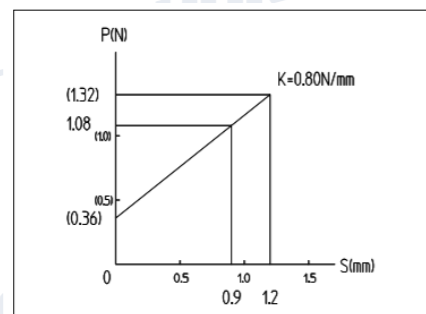

**J-3212P-1-00-0000**

0.9mm (recommended compressed stroke) : 1.08N±0.25N  
Full stroke : 1.2mm

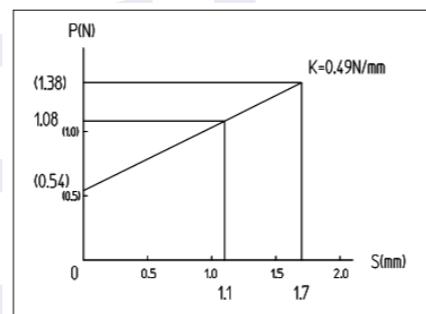

**J-4617P-1-00-0000**

0.9mm (recommended compressed stroke) : 1.08N±0.25N  
Full stroke : 1.7mm

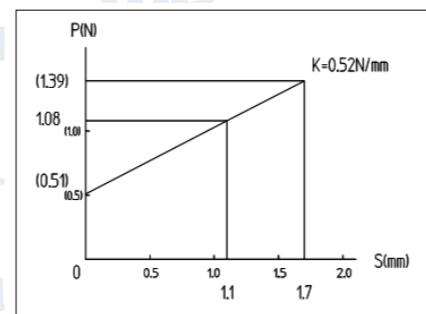

**J-5117P-1-00-0000**

1.1mm (recommended compressed stroke) : 1.08N±0.25N  
Full stroke : 1.7mm

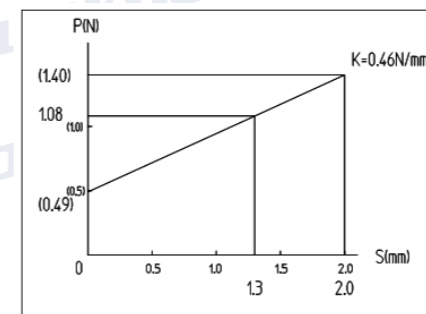

**J-5920P-1-00-0000**

1.3mm (recommended compressed stroke) : 1.08N±0.25N  
Full stroke : 2.0mm

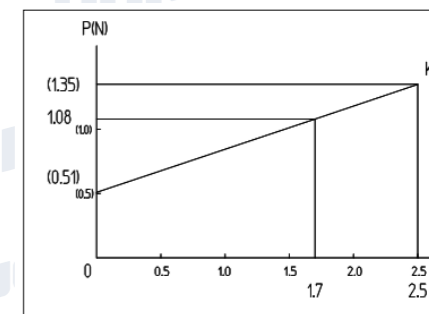

**J-7525P-1-00-0000**

1.7mm (recommended compressed stroke) : 1.08N±0.25N  
Full stroke : 2.5mm

NOTE : P : Pressure / S : Stroke  
Stroke Curve Graph per pin for each item is the same in case of ,2,3 and 4pins.